





AHS 30 Variante







Montageanleitung / Notice de montage / Assembly instruction

			
Ø5mm	34x	20x	3, 5x15





12x 10x



12x

					
Ø8x10	3, 5x15	15x	M4x10	20x	8x

20x 56x 15x 20x 8x

				
4, 5x50	2x	4, 5x15	1x	Ø8mm

1x 1x 1x 1x

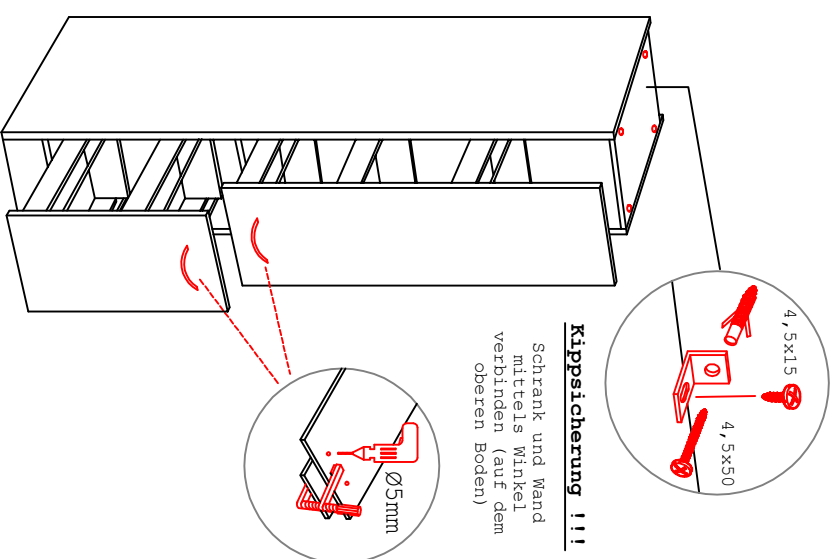
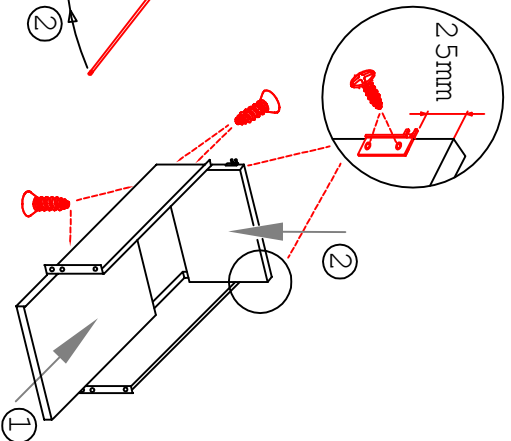
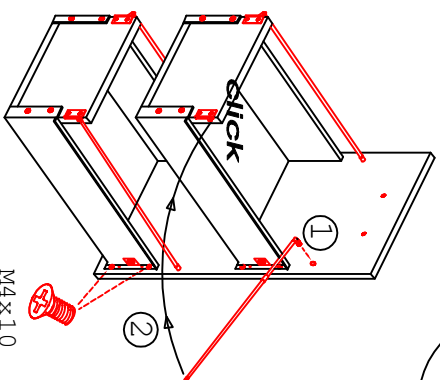
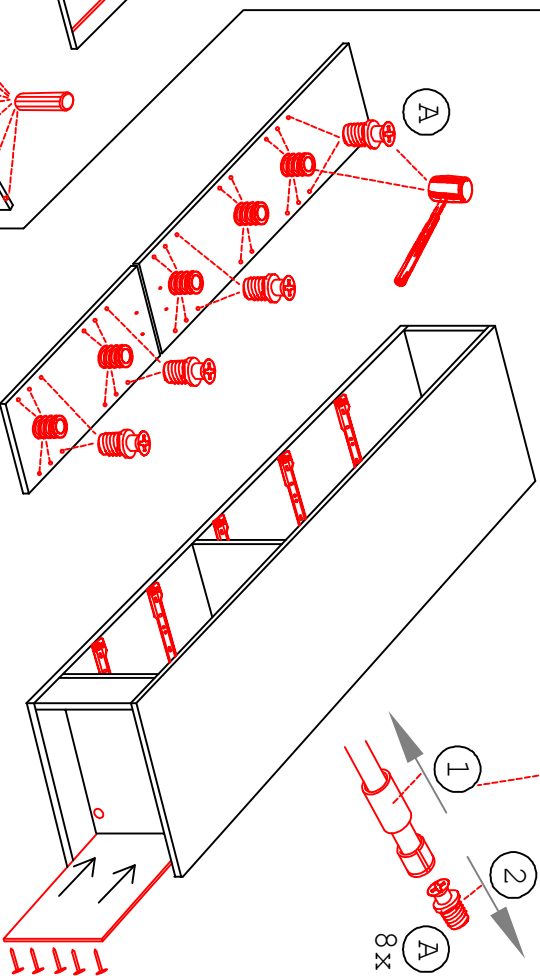
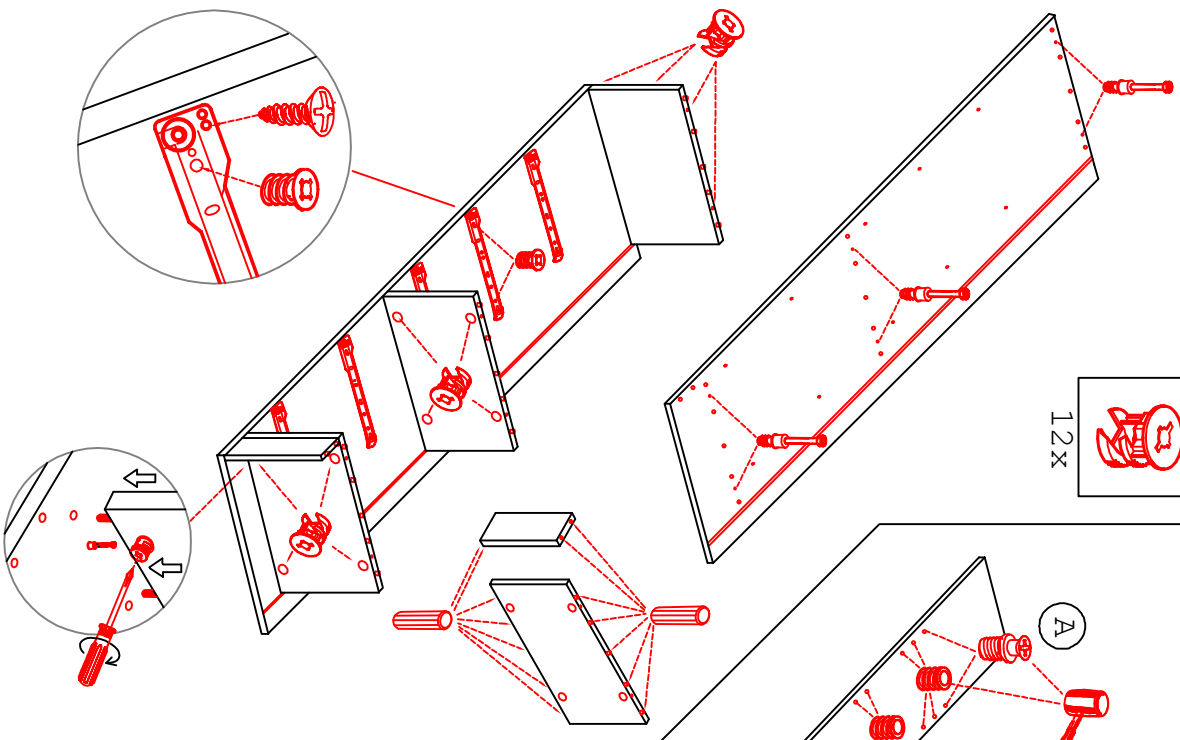

Kippsicherung !!!
Schränk und Wand mittels Winkel verbinden (auf dem oberen Boden)

Die Einstellung der Auszug-Blenden bitte durch drehen an den einzelnen Reihlingsstangen vornehmen. (heranholen oder wegdrücken)

